



KTA SPINDLE TOOLINGS

A Tool Holder Company

www.ktaspindletoolings.com



Check Stock @ Link
<http://119.81.67.54/CRMWebsite/ViewCurrentStockPosition.aspx>
And send enquiry to the nearest dealer.

2019

Precision Tool Holders & Tapping Chucks with Cylindrical Shank & Morse Taper Shank

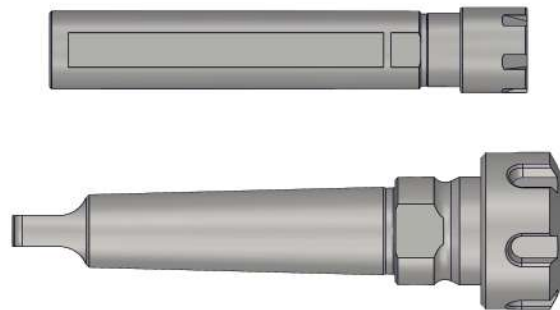

INDEX

Sr. No.	Contents		Page No.
1	Cylindrical Collet Chuck ER (DIN 6499)		203
2	Cylindrical Collet Chuck ER- M Type (DIN 6499)		204
3	Cylindrical Die & Mould Chuck (DMC)		205
4	Cylindrical Shrink Fit Holder (SFH 4.5°) (Shrinking Extention)		206
5	Cylindrical Floating Reamer Holder (FRH)		207 - 208
6	Minimum Length Compensation Tapping Chuck (MLC)		209
7	Quick Change Tapping Chucks (KWFLK) <ul style="list-style-type: none"> • Cylindrical Shank KWFLK • VDI Shank KWFLK 		210 - 211
8	Quick Change Tapping Chucks 'Q' Series <ul style="list-style-type: none"> • Cylindrical Type 'Q' Series (External) • Cylindrical Type 'Q' Series (Internal) 		212
9	Precision Tool Holders With Morse Taper Shank <ul style="list-style-type: none"> • MT (DIN 228 B) Collet Chuck ER (DIN 6499) • MT (DIN 228 A) Collet Chuck ER (DIN 6499) • MT (DIN 228 B) Quick Change Tapping Chuck (KWFLK) • MT (DIN 228 B) Quick Change Tapping Chuck 'Q' Series 		213 - 216

Maximum Run out of the Internal Taper with respect to the External Diameter 0.005 mm

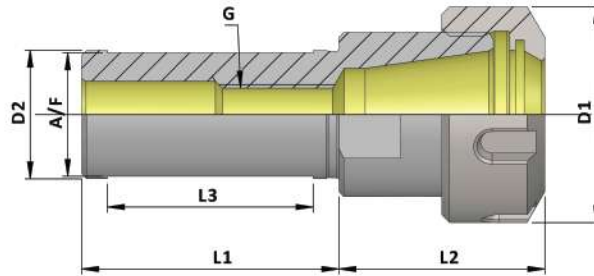

Cyl. Shank & MT Shank Holders

Cylindrical Collet Chuck ER

Item Name	Item Code	D1	D2	A/F	G	L1	L2	L3	Suitable Collet	Collet Capacity	Nut Size	Suitable Spanner
D16 ER 11 L 100	K10118148234127	19	16	-	M4	100	26	-	ER 11	0.5 - 7	ER 11	GS 17
D16 ER 11 L 150	K10118148236127	19	16	-	M4	150	26	-	ER 11	0.5 - 7	ER 11	GS 17
D16 ER 16 L 060	K10118149231127	32	16	-	M10	60	36	-	ER 16	0.5 - 10	ER 16	E16
D16 ER 16 L 100	K10118149234127	32	16	-	M10	100	36	-	ER 16	0.5 - 10	ER 16	E16
D16 ER 16 L 150	K10118149236127	32	16	-	M10	150	36	-	ER 16	0.5 - 10	ER 16	E16
D20 ER 11 L 060	K10119148231127	19	20	18	M4	60	26	50	ER 11	0.5 - 7	ER 11	GS 17
D20 ER 11 L 150	K10119148236127	19	20	-	M4	150	26	-	ER 11	0.5 - 7	ER 11	GS 17
D20 ER 16 L 050	K10119149230127	32	20	18	M10	50	31	40	ER 16	0.5 - 10	ER 16	E16
D20 ER 16 L 100	K10119149234127	32	20	-	M10	100	31	-	ER 16	0.5 - 10	ER 16	E16
D20 ER 16 L 160	K10119149330127	32	20	-	M10	160	31	-	ER 16	0.5 - 10	ER 16	E16
D20 ER 20 L 060	K10119150542127	35	20	18	M10	60	36	45	ER 20	1 - 13	ER 20	E20
D20 ER 20 L 100	K10119150234127	35	20	-	M10	100	36	-	ER 20	1 - 13	ER 20	E20
D20 ER 20 L 150	K10119150236127	35	20	-	M10	150	36	-	ER 20	1 - 13	ER 20	E20
D20 ER 25 L 050	K10119151230127	42	20	18	M12	50	46	40	ER 25	1 - 16	ER 25	E25
D25 ER 25 L 050	K10120151230127	42	25	23	M12	50	32	40	ER 25	1 - 16	ER 25	E25
D25 ER 25 L 100	K10120151234127	42	25	-	M12	100	32	-	ER 25	1 - 16	ER 25	E25
D25 ER 32 L 050	K10120152230127	50	25	23	M12	50	54	40	ER 32	2 - 20	ER 32	E32
D32 ER 25 L 070	K10121151232127	42	32	30	M12	70	28	55	ER 25	1 - 16	ER 25	E25
D32 ER 32 L 070	K10121152232127	50	32	30	M12	70	38	60	ER 32	2 - 20	ER 32	E32
D40 ER 25 L 070	K10122151578127	42	40	38	M12	70	42	60	ER 25	1 - 16	ER 25	E25
D40 ER 32 L 070	K10122152232127	50	40	38	M12	70	30	55	ER 32	2 - 20	ER 32	E32
D40 ER 40 L 080	K10122153577127	63	40	38	M16	80	60	70	ER 40	3 - 26	ER 40	E40

Accessories:



Collet ER (DIN 6499)
Ref. Page No. 233-237



Tap Collet ER-G
Ref. Page No. 238-240



Q.C.Tap Collet (QCTC)
Ref. Page No. 243-251



ER Nut
Ref. Page No.220 - 221

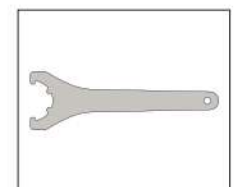

ER Spanner
Ref. Page No. 222

Note: All Dimensions are in mm

Maximum Run out of the Internal Taper with respect to the External Diameter 0.005 mm

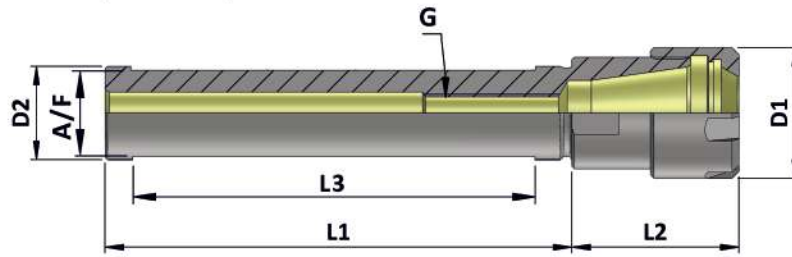

Cyl. Shank & MT Shank Holders

Cylindrical Collet Chuck ER M Type

Item Name	Item Code	D1	D2	A/F	G	L1	L2	L3	Suitable Collet	Collet Capacity	Nut Size	Suitable Spanner
D08 ER08M L 080	K10115155577127	12	8	-	M4	80	24	-	ER 08	0.5 - 5	ER 08M	E08M
D08 ER08M L 125	K10115155235127	12	8	-	M4	125	20	-	ER 08	0.5 - 5	ER 08M	E08M
D12 ER08M L 100	K10117155234127	12	12	-	M4	100	15	-	ER 08	0.5 - 5	ER 08M	E08M
D12 ER11M L 100	K10117156234127	16	12	-	M6	100	25	-	ER 11	0.5 - 7	ER 11M	E11M
D16 ER11M L 100	K10118156234127	16	16	-	M6	100	22	-	ER 11	0.5 - 7	ER 11M	E11M
D16 ER11M L 160	K10118156330127	16	16	-	M6	160	22	-	ER 11	0.5 - 7	ER 11M	E11M
D16 ER16M L 060	K10118157542127	22	16	-	M8	60	37	-	ER 16	0.5 - 10	ER 16M	E16M
D16 ER16M L 160	K10118157330127	22	16	-	M8	160	37	-	ER 16	0.5 - 10	ER 16M	E16M
D20 ER11M L 050	K10119156230127	16	20	18	M6	50	22	40	ER 11	0.5 - 7	ER 11M	E11M
D20 ER11M L 100	K10119156234127	16	20	-	M6	100	22	-	ER 11	0.5 - 7	ER 11M	E11M
D20 ER16M L 060	K10119157542127	22	20	18	M10	60	30	50	ER 16	0.5 - 10	ER 16M	E16M
D20 ER16M L 100	K10119157234127	22	20	-	M10	100	30	-	ER 16	0.5 - 10	ER 16M	E16M
D20 ER16M L 130	K10119157487127	22	20	-	M10	130	30	-	ER 16	0.5 - 10	ER 16M	E16M
D20 ER16M L 160	K10119157330127	22	20	-	M10	160	30	-	ER 16	0.5 - 10	ER 16M	E16M
D20 ER16M L 200	K10119157237127	22	20	-	M10	200	30	-	ER 16	0.5 - 10	ER 16M	E16M
D20 ER20M L 060	K10119158542127	28	20	18	M10	60	37	45	ER 20	1 - 13	ER 20M	E20M
D20 ER20M L 100	K10119158234127	28	20	-	M10	100	37	-	ER 20	1 - 13	ER 20M	E20M
D20 ER20M L 130	K10119158487127	28	20	-	M10	130	37	-	ER 20	1 - 13	ER 20M	E20M
D20 ER20M L 160	K10119158330127	28	20	-	M10	160	37	-	ER 20	1 - 13	ER 20M	E20M
D20 ER20M L 200	K10119158237127	28	20	-	M10	200	37	-	ER 20	1 - 13	ER 20M	E20M
D20 ER25M L 100	K10119159234127	35	20	-	M10	100	46	-	ER 25	1 - 16	ER 25M	E25M
D25 ER25M L 160	K10119159330127	35	25	-	M10	160	32	-	ER 25	1 - 16	ER 25M	E25M

Accessories:



Collet ER (DIN 6499)
Ref. Page No. 233-237



ER M Type Nut & Sealed Nut
Ref. Page No. 220-221 & 224-225



Sealing Disc
Ref. Page No. 226-231

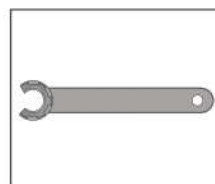

ER M Type Spanner
Ref. Page No. 222

Note: All Dimensions are in mm

Maximum Run out of the Internal Taper with respect to the External Diameter < 0.005 mm

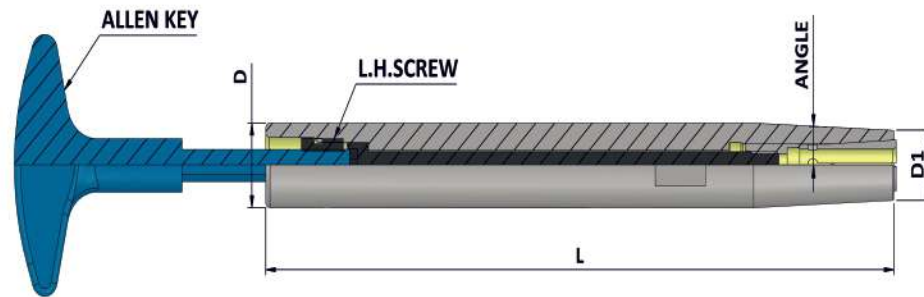

Cyl. Shank & MT Shank
Holders

Cylindrical (DMC)

Item Name	Item Code	Gripping Range	D	D1	L	Angle	Collet	Screw	Allen Key
D16 DMC 06 L 150	K10118161236127	3-6	16	13	150	3	DMC-6	M5	4X200
D20 DMC 06 L 200	K10119161237127	3-6	20	13	200	3	DMC-6	M5	4X200
D25 DMC 06 L 250	K10120161256127	3-6	25	13	250	3	DMC-6	M5	4X200
D20 DMC 08 L 150	K10119162236127	3-8	20	19	150	3	DMC-8	M6	5X200
D20 DMC 08 L 200	K10119162237127	3-8	20	19	200	3	DMC-8	M6	5X200
D25 DMC 10 L 150	K10120163236127	3-10	25	24	150	-	DMC-10	M8	6X200
D25 DMC 10 L 200	K10120163237127	3-10	25	24	200	-	DMC-10	M8	6X200
D25 DMC 10 L 250	K10120163256127	3-10	25	24	250	-	DMC-10	M8	6X200

Accessories:



DMC Collet
Ref. Page No. 241

Note: All Dimensions are in mm

Maximum Run out of the Internal Diameter with respect to the External Diameter 0.003

Cyl. Shank & MT Shank Holders

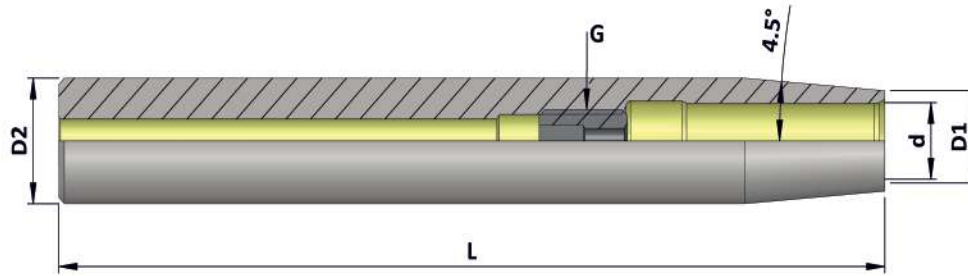

Cylindrical Shank (SFH 4.5°)

Item Name	Item Code	d	D1	D2	G	L
D12 SFH03 150	K10117274173127	3	8	12	-	150
D12 SFH04 150	K10117275173127	4	8	12	-	150

D16 SFH03 150	K10118274173127	3	10	16	-	150
D16 SFH04 150	K10118275173127	4	10	16	-	150
D16 SFH05 150	K10118276173127	5	10	16	-	150
D16 SFH06 150	K10118277173127	6	10	16	M5	150

D20 SFH03 150	K10119274173127	3	10	20	-	150
D20 SFH04 150	K10119275173127	4	10	20	-	150
D20 SFH05 150	K10119276173127	5	10	20	-	150
D20 SFH06 150	K10119277173127	6	10	20	M5	150
D20 SFH08 150	K10119285173127	8	12	20	M6	150
D20 SFH10 150	K10119279173127	10	14	20	M8	150
D20 SFH12 150	K10119280173127	12	16	20	M10	150

D25 SFH08 150	K10120285173127	8	20	25	M6	150
D25 SFH10 150	K10120279173127	10	20	25	M8	150
D25 SFH12 150	K10120280173127	12	20	25	M10	150
D25 SFH14 150	K10120284173127	14	20	25	M10	150
D25 SFH16 150	K10120281173127	16	22	25	M12	150

D32 SFH10 150	K10121279173127	10	24	32	M8	150
D32 SFH12 150	K10121280173127	12	24	32	M10	150
D32 SFH14 150	K10121284173127	14	27	32	M10	150
D32 SFH16 150	K10121281173127	16	27	32	M12	150
D32 SFH18 150	K10121282173127	18	27	32	M12	150
D32 SFH20 150	K10121283173127	20	27	32	M16	150

Note: All Dimensions are in mm

◆ Features :

- This is a short length Floating Reamer Holder with radial parallel float of 1.0 mm.
- This has got a special mechanism of weight balancing at the end.
- This can be used on any CNC Lathe.
- This solves almost all Reaming problems such as; over size cutting; bell-mouth; surface finish.
- Best suitable for correct size with repeatability; with very good Surface finish.
- This Floating Reamer Holder is with (ER 25 A Collet Chuck)

◆ Range :

- 2.0 to 16.0 mm.

◆ Available In Mounting :

- Available with cylindrical shank Dia. 20, 25 & 32 mm as per DIN 1835 B+E.



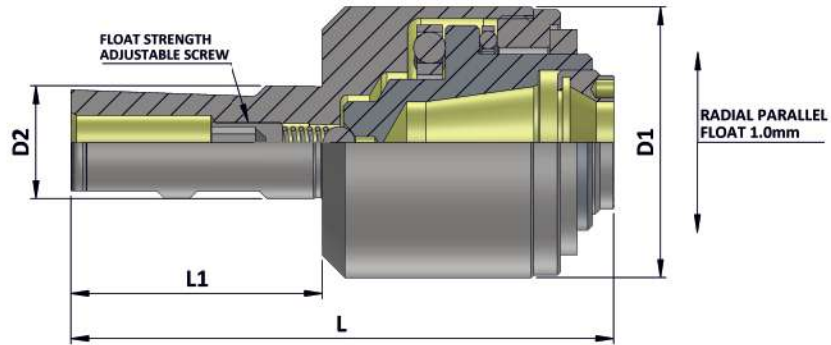

Cylindrical Shank (DIN 1835 B+E) (FRH)

Item Name	Item Code	D1	D2	L	L1	Collet Capacity	Spanner	Radial Parallel Float
FRH DIA 20 ER 25A 116	K10160289302127	60	20	116	51	1 - 16	E25A	1.0mm
FRH DIA 25 ER 25A 121	K10140243240127	60	25	121	56	1 - 16	E25A	1.0mm
FRH DIA 32 ER 25A 126	K10141243263127	60	32	126	61	1 - 16	E25A	1.0mm

Accessories:



Collet ER (DIN 6499)
Ref. Page No. 233-237



ER A Type Nut
Ref. Page No. 220-221

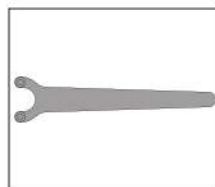

ER A Type Spanner
Ref. Page No. 222

Note: All Dimensions are in mm

Maximum Run out of the Internal Taper with respect to the External Diameter 0.020 mm

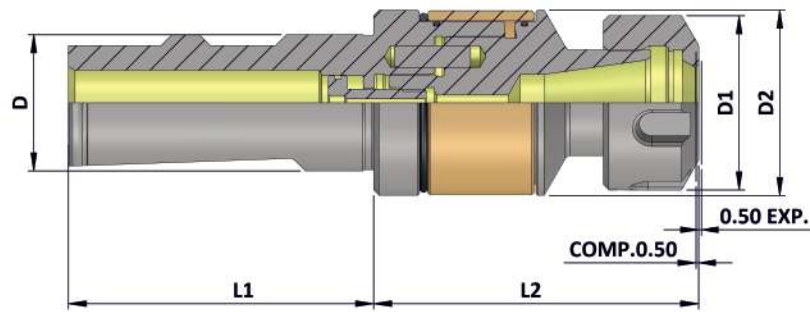

Cyl. Shank & MT Shank Holders

Cylindrical Shank (DIN 1835 B+E) (MLC)

Item Name	Item Code	Capacity	Clamping Range	Nut Size	D	D1	D2	L1	L2	Comp.	Exp.
D20 ER 16M L 58 MLC	K10119157552245	M3-M12	1-10	ER 16M	20	22	34	51	58	0.5	0.5
D20 ER 16 L 58 MLC	K10119149552245	M3-M12	1-10	ER 16	20	32	34	51	58	0.5	0.5
D25 ER 16M L 60 MLC	K10120157117245	M3-M12	1-10	ER 16M	25	22	34	56	60	0.5	0.5
D25 ER 16 L 60 MLC	K10120149542245	M3-M12	1-10	ER 16	25	32	34	56	60	0.5	0.5
D25 ER 20 L 61 MLC	K10120150561245	M3-M16	3.5-10	ER 20	25	35	34	56	61	0.5	0.5
D25 ER 25 L 65 MLC	K10120151553245	M3-M20	3.5-16	ER 25	25	42	34	56	65	0.5	0.5
D25 ER 32 L 87 MLC	K10120152555245	M4-M27	3.5-20	ER 32	25	50	45	56	87	0.5	0.5
D32 ER 40 L 108.5 MLC	K10121153119245	M6-M33	6-26	ER 40	32	63	62	61	108.5	0.5	0.5

Accessories:



Tap Collet ER-G
Ref. Page No. 238-240



Q.C.Tap Collet QCTC
Ref. Page No. 243-251



ER Nut
Ref. Page No. 220-221

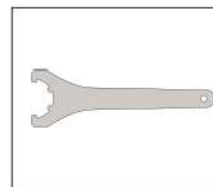

ER Spanner
Ref. Page No. 222

Note: All Dimensions are in mm

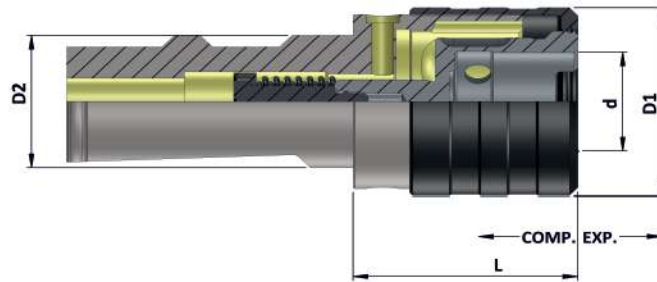

Cylindrical Shank (DIN 1835 B+E) KWFLK

Item Name	Item Code	Capacity	Suitable Adaptor	Comp.	Exp.	d	D1	D2	L
DIA 16 KWFLK0	K11208267193	M1 - M 10	KWES 0B	6.5	6.5	13	26	16	37
DIA 20 KWFLK0	K11176267193	M1 - M 10	KWES 0B	6.5	6.5	13	26	20	37
DIA 20 KWFLK 1	K11176233193	M3 - M12	KWES 1B	7.5	7.5	19	36	20	40
DIA 25 KWFLK 1	K11177233193	M3 - M12	KWES 1B	7.5	7.5	19	36	25	40
DIA 25 KWFLK 2	K11177234193	M8 - M20	KWES 2B	12.5	12.5	31	53	25	63
DIA 32 KWFLK 1	K11178233193	M3 - M12	KWES 1B	7.5	7.5	19	36	32	40
DIA 32 KWFLK 2	K11178234193	M8 - M20	KWES 2B	12.5	12.5	31	53	32	63
DIA 32 KWFLK 3	K11178235193	M14 - M33	KWES 3B	20	20	48	78	32	125
DIA 40 KWFLK 1	K11179233193	M3 - M12	KWES 1B	7.5	7.5	19	36	40	40
DIA 40 KWFLK 2	K11179234193	M8 - M20	KWES 2B	12.5	12.5	31	53	40	63
DIA 40 KWFLK 3	K11179235193	M14 - M33	KWES 3B	20	20	48	78	40	125
DIA 40 KWFLK 4	K11179236193	M22 - M48	KWES 4B	22.5	22.5	60	96	40	126
DIA 50 KWFLK 4	K11180236193	M22 - M48	KWES 4B	22.5	22.5	60	96	50	126
DIA 3/4" KWFLK 1	K10221169301127	M3 - M12	KWES 1B	7.5	7.5	19	36	3/4"	40
DIA 1" KWFLK 1	K10219169301127	M3 - M12	KWES 1B	7.5	7.5	19	36	1"	40
DIA 1" KWFLK 2	K10219170301127	M8 - M20	KWES 2B	12.5	12.5	31	53	1"	63
DIA 1 - 1/2" KWFLK 3	K11211235193	M14 - M33	KWES 3B	20	20	48	78	1 - 1/2"	125

Accessories:

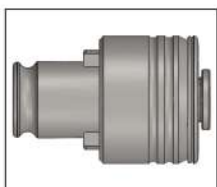

Tap Adaptor KWES..B & KWESK..B
Ref. Page No. 260-279



Tap Adaptor
Reduction Socket KWRE
Ref. Page No. 280

Note: • All Dimensions are in mm
• For Tap Shank Dimension & Recommended Torque Values Ref. Page No. 281-284

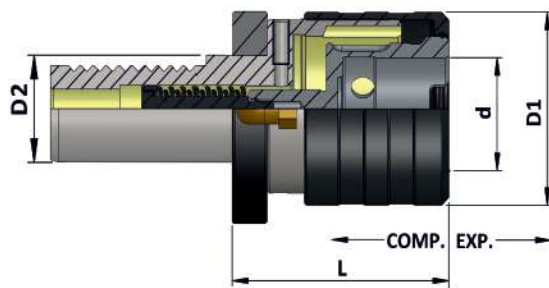

Cyl. Shank & MT Shank Holders

VDI Shank KWFLK

Item Name	Item Code	Capacity	Suitable Adaptor	Comp.	Exp.	d	D1	D2	L
VDI 20 KWFLK1	K10284169522127	M3 - M12	KWES 1B	7.5	7.5	19	36	20	52
VDI 25 KWFLK1	K10285169522127	M3 - M12	KWES 1B	7.5	7.5	19	36	25	52
VDI30 KWFLK1	K10261169522127	M3 - M12	KWES 1B	7.5	7.5	19	36	30	55
VDI40 KWFLK1	K10262169522127	M3 - M12	KWES 1B	7.5	7.5	19	36	40	55
VDI50 KWFLK1	K10263169522127	M3 - M12	KWES 1B	7.5	7.5	19	36	50	55
VDI 25 KWFLK2	K10285170480127	M8 - M20	KWES 2B	12.5	12.5	31	53	25	76
VDI30 KWFLK2	K10261170480127	M8 - M20	KWES 2B	12.5	12.5	31	53	30	76
VDI40 KWFLK2	K10262170480127	M8 - M20	KWES 2B	12.5	12.5	31	53	40	76
VDI50 KWFLK2	K10263170480127	M8 - M20	KWES 2B	12.5	12.5	31	53	50	76
VDI40 KWFLK3	K10262171481127	M14 - M33	KWES 3B	20	20	48	78	40	130
VDI50 KWFLK3	K10263171481127	M14 - M33	KWES 3B	20	20	48	78	50	107

Accessories:

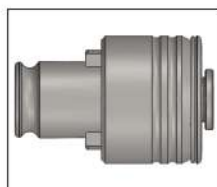

Tap Adaptor KWES..B & KWESK..B
Ref. Page No. 260-279



Tap Adaptor
Reduction Socket KWRE
Ref. Page No. 280

Note: • All Dimensions are in mm
• For Tap Shank Dimension & Recommended Torque Values Ref. Page No. 281-284

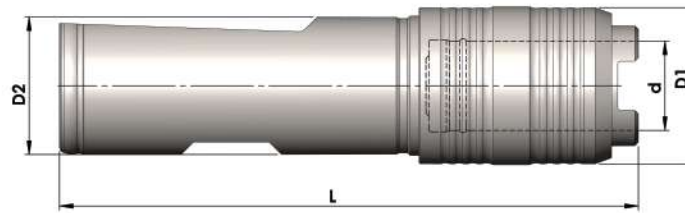

Q (Cylindrical Type)

(No Compression & No Expansion)

Item Name	Item Code	Capacity	Suitable Adaptor	d	D1	D2	L
DIA 16 Q 0	K11208241193	M1-M10	KWES0B/KWE0	13	23	16	33
DIA 20 Q 0	K11176241193	M1-M10	KWES0B/KWE0	13	23	20	33

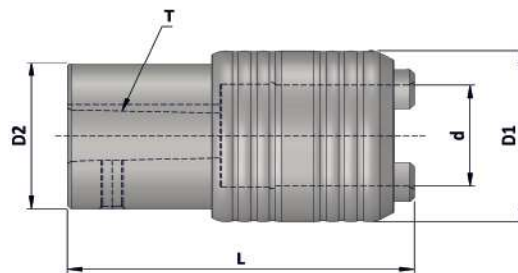

Q (Short Internal Tapper)

(No Compression & No Expansion)

Item Name	Item Code	Capacity	Suitable Adaptor	d	D1	D2	T	L
INTERNAL B12 Q 3-12	K11245266193	M3 - M12	KWES1B / KWE1	19	32	27.9	B12	59
INTERNAL B16 Q 8-20	K11246241225	M8 - M20	KWES2B / KWE2	31	50	44.8	B16	80
INTERNAL B18 Q 8-20	K11247241225	M8 - M20	KWES2B / KWE2	31	50	44.8	B18	88

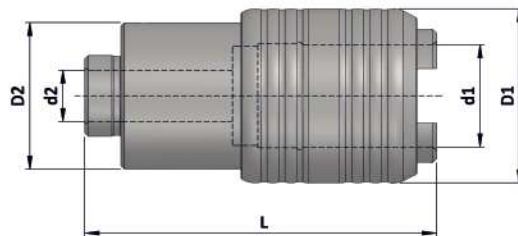

Q (Internal Dia.)

(No Compression & No Expansion)

Item Name	Item Code	Capacity	Suitable Adaptor	d1	d2	D1	D2	L
INTERNAL DIA 16 Q 8-20	K11233241225	M8 - M20	KWES2B / KWE2	31	16	50	44.8	86.5
INTERNAL DIA 25 Q 8-20	K11243241225	M8 - M20	KWES2B / KWE2	31	25	50	44.8	103
INTERNAL DIA 25 Q 14-33	K11243241226	M14 - M33	KWES3B / KWE3	48	25	72	67.4	124.5
INTERNAL DIA 35 Q 22-48	K11258241265	M22 - M48	KWES4B / KWE4	60	35	92	84	139

Note: All Dimensions are in mm
For Necessary Accessories Selection Please refer Page No. 260-280

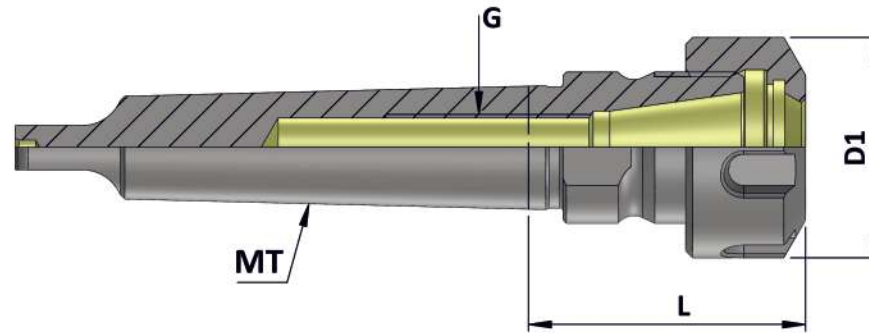

Cyl. Shank & MT Shank
Holders

Morse Taper (DIN 228 B) Collet Chuck ER

Item Name	Item Code	D1	G	L	Suitable Collet	Collet Capacity	Nut Size	Spanner
MT 2B ER 16 042	K10129149107127	32	M6	42	ER 16	0.5 - 10	ER 16	E16
MT 2B ER 20 048	K10129150110127	35	M8	48	ER 20	1 - 13	ER 20	E20
MT 3B ER 25 052	K10130151113127	42	M10	52	ER 25	1 - 16	ER 25	E25
MT 3B ER 32 070	K10130152125127	50	M12	70	ER 32	2 - 20	ER 32	E32
MT 4B ER 32 054	K10131152114127	50	M12	54	ER 32	2 - 20	ER 32	E32
MT 4B ER 40 075	K10131153127127	63	M16	75	ER 40	3 - 26	ER 40	E40
MT 4B ER 50 105	K10131154152127	78	M16	105	ER 50	10 - 34	ER 50	E50
MT 5B ER 40 082	K10132153255127	63	M16	82	ER 40	3 - 26	ER 40	E40
MT 5B ER 50 100	K10132154148127	78	M16	100	ER 50	10 - 34	ER 50	E50

Accessories:



Collet ER (DIN 6499)
Ref. Page No. 233-237



ER Nut Ref. Page No.
220-221

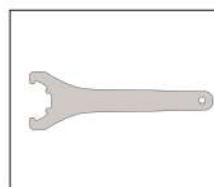

ER Spanner
Ref. Page No. 222

Note: All Dimensions are in mm

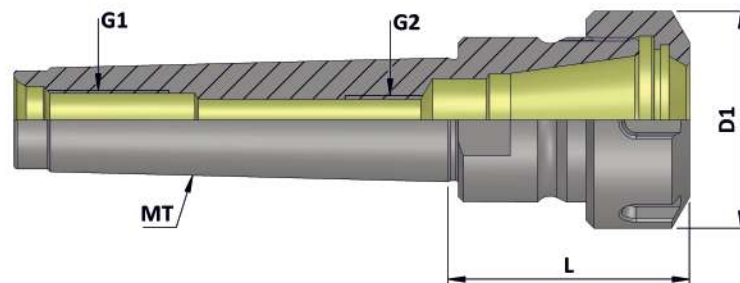

Morse Taper (DIN 228 A) Collet Chuck ER

Item Name	Item Code	D1	G1	G2	L	Suitable Collet	Collet Capacity	Nut Size	Spanner
MT 2A ER 16 042	K10124149107127	32	M10	M6	42	ER 16	0.5 - 10	ER 16	E16
MT 2A ER 20 048	K10124150110127	35	M10	M8	48	ER 20	1 - 13	ER 20	E20
MT 3A ER 25 052	K10125151113127	42	M12	M10	52	ER 25	1 - 16	ER 25	E25
MT 3A ER 32 070	K10125152125127	50	M12	M12	70	ER 32	2 - 20	ER 32	E32
MT 4A ER 32 054	K10126152114127	50	M16	M12	54	ER 32	2 - 20	ER 32	E32
MT 4A ER 40 075	K10126153127127	63	M16	M16	75	ER 40	3 - 26	ER 40	E40
MT 4A ER 50 105	K10126154152127	78	M16	M16	105	ER 50	10 - 34	ER 50	E50
MT 5A ER 40 082	K10127153255127	63	M20	M16	82	ER 40	3 - 26	ER 40	E40
MT 5A ER 50 100	K10127154148127	78	M20	M16	100	ER 50	10 - 34	ER 50	E50

Accessories:



Collet ER (DIN 6499)
Ref. Page No. 233-237



ER Nut Ref. Page No.
220-221

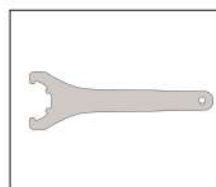

ER Spanner
Ref. Page No. 222

Note: All Dimensions are in mm

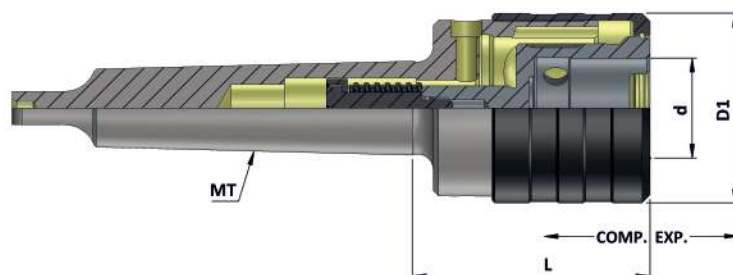

Morse Taper (DIN 228 B) (KWFLK)

Item Name	Item Code	Capacity	Suitable Adaptor	Comp.	Exp.	d	D1	L
MT2B KWFLK1	K11227233193	M3 - M12	KWES1B	7.5	7.5	19	36	47
MT3B KWFLK1	K11228233193	M3 - M12	KWES1B	7.5	7.5	19	36	47
MT3B KWFLK2	K11228234193	M8 - M20	KWES2B	12.5	12.5	31	53	71
MT4B KWFLK2	K11213234193	M8 - M20	KWES2B	12.5	12.5	31	53	72
MT4B KWFLK3	K11213235193	M14 - M33	KWES3B	20	20	48	78	105
MT4B KWFLK3 WITH KEEPER SLOT	K11213235240	M14 - M33	KWES3B	20	20	48	78	105
MT5B KWFLK3	K11215235193	M14 - M33	KWES3B	20	20	48	78	105
MT5B KWFLK3 WITH KEEPER SLOT	K11215235240	M14 - M33	KWES3B	20	20	48	78	105
MT5B KWFLK4	K11215236193	M22 - M48	KWES4B	22.5	22.5	60	96	117

Accessories:

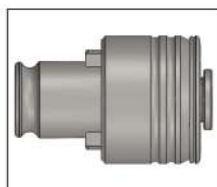

Tap Adaptor KWES..B & KWESK..B
Ref. Page No. 260-279



Tap Adaptor
Reduction Socket KWRE
Ref. Page No. 280

Note: • All Dimensions are in mm
• For Tap Shank Dimension & Recommended Torque Values Ref. Page No. 281-284

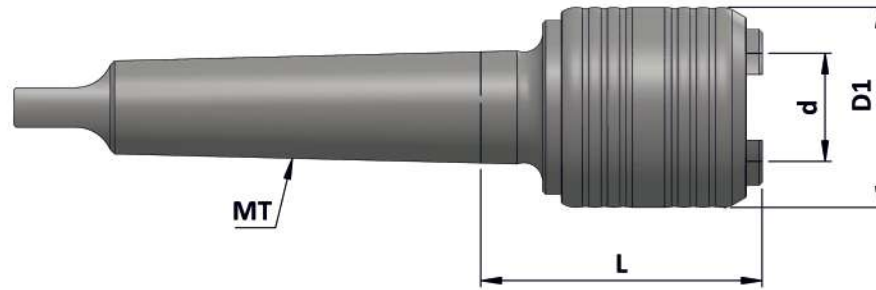

Q (Morse Taper)

(No Compression & No Expansion)

Item Name	Item Code	Capacity	Suitable Adaptor	d	D1	L
MT 2 B Q 3-12	K11201241223	M3 - M12	KWES1B/KWE1	19	32	40
MT 3 B Q 3-12	K11202241223	M3 - M12	KWES1B/KWE1	19	32	40
MT 2 B Q 8-20	K11201241225	M8 - M20	KWES2B/KWE2	31	50	61
MT 3 B Q 8-20	K11202241225	M8 - M20	KWES2B/KWE2	31	50	61

Accessories:

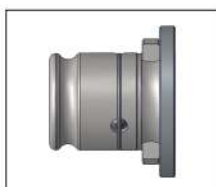

Tap Adaptor
Reduction Socket KWRE
Ref. Page No. 280

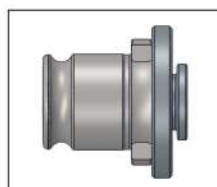

Tap Adaptor KWE
Ref. Page No. 252-259



Tap Adaptor KWES..B & KWESK..B
Ref. Page No. 260-279



Note: All Dimensions are in mm
For Tap Shank Dimension & Recommended Torque Values Ref. Page No. 281-284